



Technical Specifications

Dimafix® is a smart adhesive that varies its adherence properties according to the temperature, in the range usually used for 3D printing. Figure 1 shows how Dimafix® increases adherence as the printing bed is heated in a test performed using ABS and a regular flat glass hot-bed.

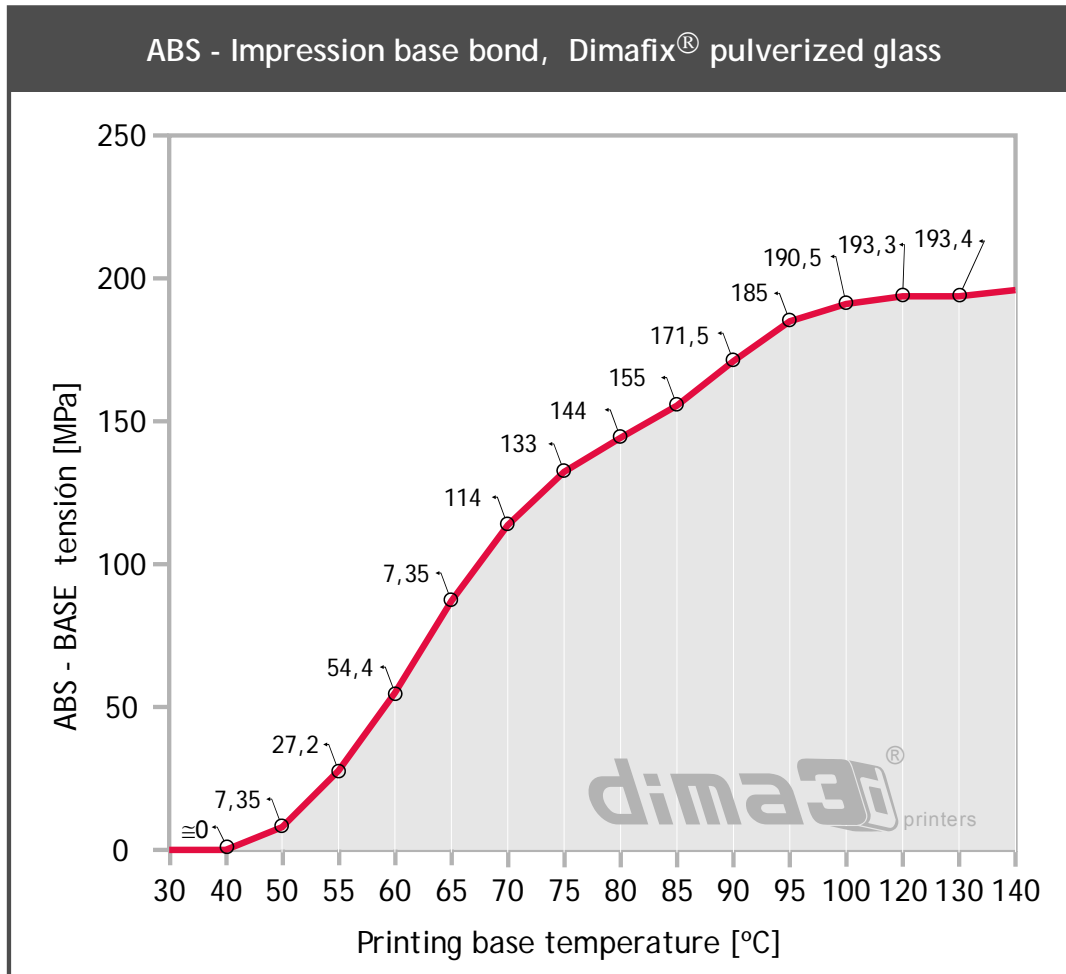

Figure 1. ABS – Printing bed tension variation depending on the temperature

Dimafix® provides maximum ABS adherence to printing surfaces made of regular, heat-treated or borosilicate glasses. For each printing and type of piece there is an optimal temperature for which Dimafix® completely avoids warping, as it is represented in Figure 2.

Dimafix® behaviour with ABS

Dimafix® provides different adherence values between the printed parts and the bed as the temperature varies. This is an essential feature for 3D printing and allows to distinguish four regions of operation where the user can obtain different useful behaviours by setting different



temperature values in the 3D printer's bed. These behaviours will allow to print ABS easily and successfully.

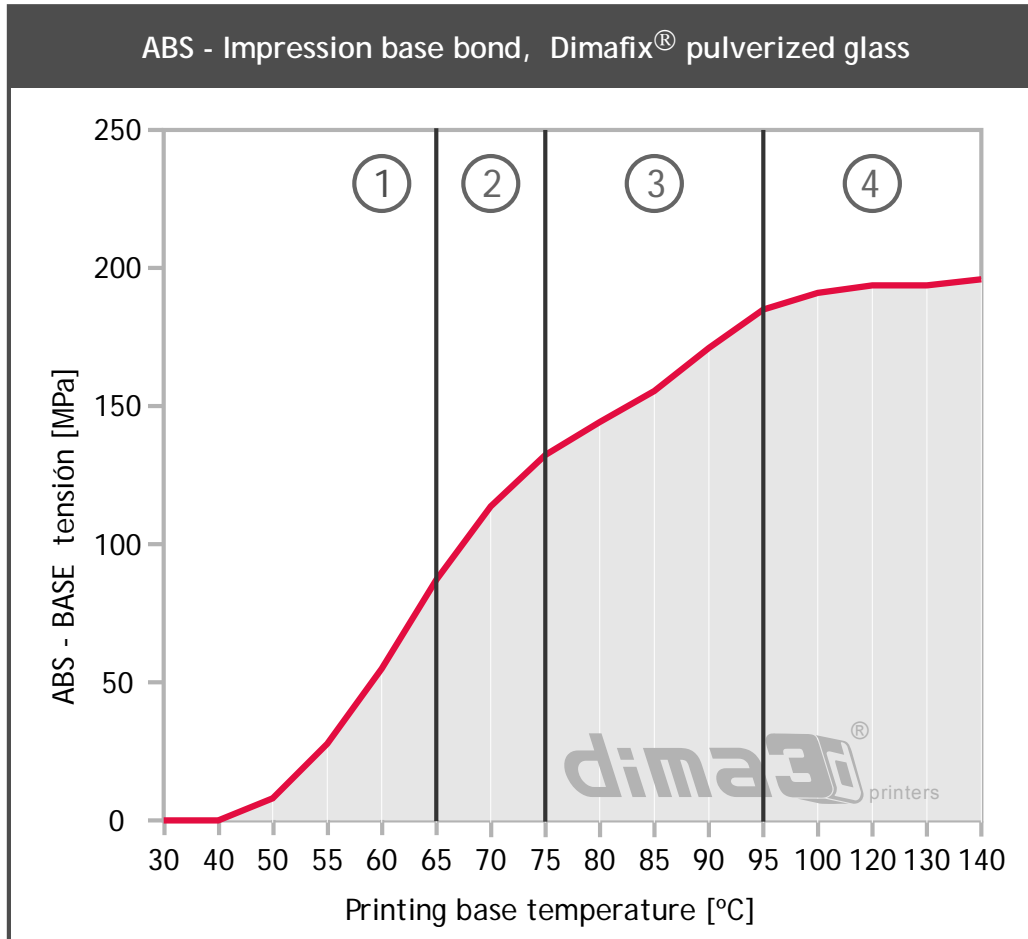

Figure 2. Dimafix® operation regions

These four operating temperature ranges vary the adherence power of Dimafix®. Some printing recommendations are given below depending on the type of piece to be printed (also summarised in Figure 3).

Zona 4. Bed temperature between 95°C and 120°C (203°F - 248°F)

Maximum adherence region. Any piece size and geometry can be printed without warping. The adherence tension between the piece and the bed is maximum, allowing any stress concentration factor. These are the optimum values to guarantee the best quality in sharp edges and vertices, which generally tend to concentrate internal tensions due to temperature.

These settings are also recommended to print large and complex pieces that require long printing times. The maximum area tested so far has been 480 mm × 240 mm (18.9 × 9,45 inches) continuously printing during more than 48 hours.



Zona 3. Bed temperature between 75°C and 95°C (167°F - 203°F)

High adherence region. Any type of geometry can be printed, especially for those pieces up to 200 × 200 mm (7,87 × 7,87 inches), the most common size for desktop 3D printers. It is recommended for good quality in sharp edges and vertices not affected by high cooling tensions (due to the stress concentration caused by temperature). It can also provide good results for long printing times.

Zona 2. Bed temperature between 65°C and 75°C (149°F - 167°F)

Medium adherence region. Recommended for simple pieces without sharp edges, vertices or complex geometries. Useful for rounded bases, chamfers, curves, etc., avoiding sharp edges or slim profiles which are long and thick at the same time. Also used for medium printing times.

Zona 1. Bed temperature below 65°C (149°F)

Self-detachment region. As long as the bed is cooled below this temperature, the printed parts detach from the bed automatically on their own, without any user action.

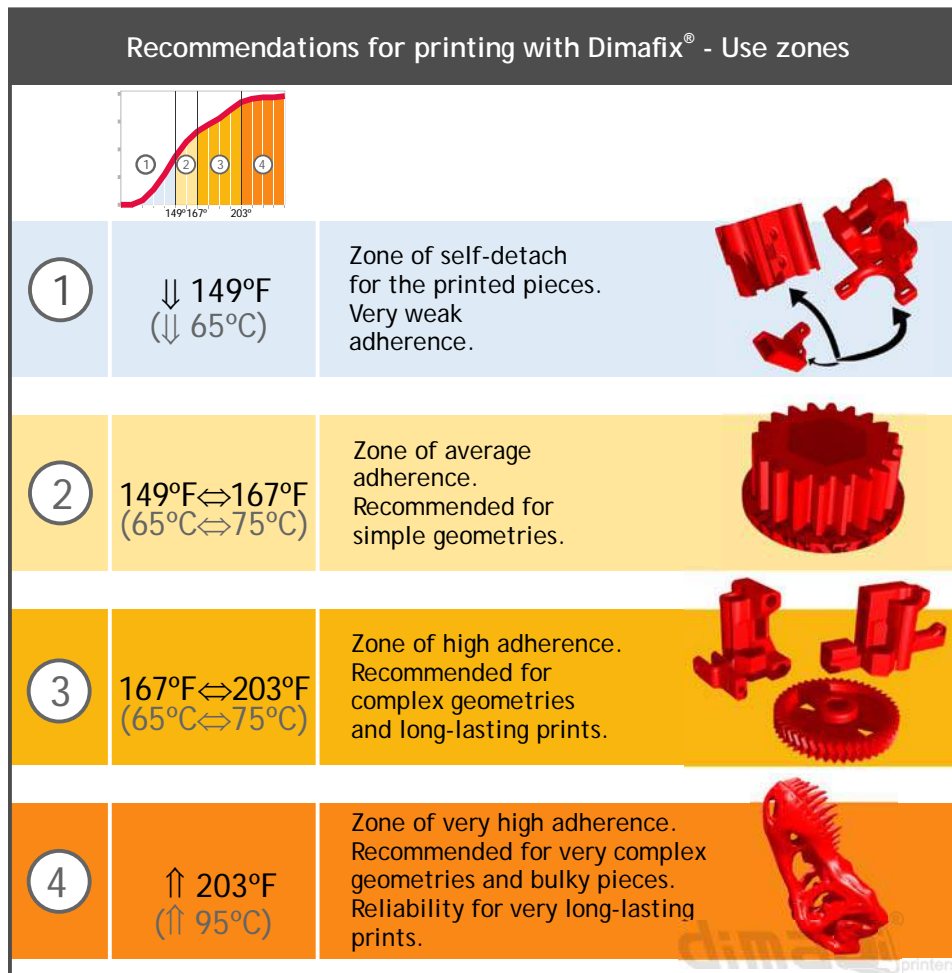

Figure 3. Dimafix® features for different operating temperature ranges



Tensions and strains analysis

Dimafix® creates an interface between the polymer (ABS) and the substratum (glass) that provides the required adherence to avoid internal tensions (created by the multidimensional thermal gradient) to detach the printings from the bed.

According to solid elasticity studies, every solid geometry free from physical constraints, isotropic, homogeneous and with a linear thermal gradient (it warms up homogeneously), is deformed without any internal tension. However, in our case:

- 1- The solid is bond to the adhesive Dimafix® interface to achieve a completely flat surface without any deformation. Therefore the solid is not free and has physical restrictions in the face next to the glass.
- 2- The thermal gradient is not linear. There are to heat sources, one due to the funded material deposition coming out from the extruder, and the other one due to the heating of the printing bed (which activates the properties of Dimafix®).
- 3- The solid is not isotropic because it is 3D printed. It is built with successive polymer layers deposition, therefore preventing the existence of isotropy.

A Finite Element Analysis (FEA) has been carried out taking into account all the previous concerns, assisted by the CAE software (Computer Aided Engineering) ANSYS V.14, using the modules “Steady-State Thermal” and “Static Structural”.

This study had the following conditions and considerations:

- 1- The geometry to be printed is represented in Figure 4. It will be printed as it is shown: supporting only over its minor and slim base. This geometry is commonly used in 3D printing to test adherence to the printing bed.

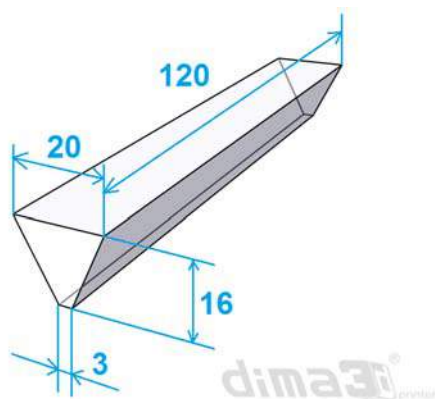

Figure 4. Geometry of the piece to be printed (size in mm)

- 2- Own database of printing material properties. Figure 5 shows the ABS data from MATWEB for the temperature values of the different geometry positions.



Overview of materials for Acrylonitrile Butadiene Styrene (ABS), Extruded			
Physical Properties	Metric	English	Comments
Density	0.350 - 3.50 g/cc	0.0126 - 0.126 lb/in ³	Average value: 1.06 g/cc Grade Count:377
Water Absorption	0.0250 - 2.30 %	0.0250 - 2.30 %	Average value: 0.407 % Grade Count:78
Moisture Absorption at Equilibrium	0.150 - 0.220 %	0.150 - 0.220 %	Average value: 0.200 % Grade Count:23
Water Absorption at Saturation	0.300 - 1.03 %	0.300 - 1.03 %	Average value: 0.734 % Grade Count:20
Viscosity	255000 - 255000 cP @Temperature 240 - 240 °C	255000 - 255000 cP @Temperature 464 - 464 °F	Average value: 255000 cP Grade Count:1
Mechanical Properties	Metric	English	Comments
Hardness, Rockwell R	90.0 - 119	90.0 - 119	Average value: 107 Grade Count:209
Hardness, H358/30	85.0 - 104 MPa	12300 - 15100 psi	Average value: 93.1 MPa Grade Count:9
Ball Indentation Hardness	80.0 - 120 MPa	11600 - 17400 psi	Average value: 98.6 MPa Grade Count:24
Tensile Strength, Ultimate	24.1 - 73.1 MPa	3500 - 10600 psi	Average value: 38.5 MPa Grade Count:148
	20.0 - 52.0 MPa @Temperature -18.0 - 90.0 °C	2900 - 7540 psi @Temperature -0.400 - 194 °F	Average value: 35.8 MPa Grade Count:3
Tensile Strength, Yield	20.0 - 73.1 MPa	2900 - 10600 psi	Average value: 43.2 MPa Grade Count:329
	64.0 - 64.0 MPa @Temperature -18.0 °C	9280 - 9280 psi @Temperature -0.400 °F	Average value: 64.0 MPa Grade Count:1
Elongation at Break	1.40 - 110 %	1.40 - 110 %	Average value: 25.2 % Grade Count:247
	15.0 - 15.0 % @Temperature -18.0 °C	15.0 - 15.0 % @Temperature -0.400 °F	Average value: 15.0 % Grade Count:1
Elongation at Yield	1.70 - 20.0 %	1.70 - 20.0 %	Average value: 3.41 % Grade Count:129
Modulus of Elasticity	0.778 - 6.10 GPa	113 - 885 ksi	Average value: 2.30 GPa Grade Count:220
	2.81 - 2.81 GPa @Temperature -18.0 °C	408 - 408 ksi @Temperature -0.400 °F	Average value: 2.81 GPa Grade Count:1

Figure 5. Engineering data from MATWEB

- 3- Temperature boundary conditions:
 - a. Extruder temperature: 240°C (464°F). Uniformly applied in the upper face of the piece, as a simplification of the real thermal distribution generated by the nozzle.
 - b. Homogeneous natural convection in the four sides:
 - i. Approximated temperature: 18,6°C (65,48°F).
 - ii. Fluid: air.
 - iii. Air speed: 0,01m/s (0,022 miles per hour).
 - iv. Relative humidity: 91%.
 - c. Bed temperature variable depending on the trial.
- 4- Application of uniformly sprayed Dimafix® over the area of the glass where the piece will be printed.
- 5- Glass printing surface, borosilicate derivatives without surface treatment.

Five different temperature values for the printing bed will be studied, determining the temperature gradients that generate, next to the base constraint, the appearance of internal tensions to be studied later on.



Analysis of the multidimensional thermal gradient

The piece has zones at different temperatures while it is printed. These temperature variations in the solid, next to the boundary conditions already described, generate internal tensions and hence deformations.

The multidimensional thermal gradient has to be known to study the deformations, this is, the spatial thermal function per volume differential of the geometry. The different regions of the solid will be limited by isothermal curves. The portion of solid for each volume differential will be at the same temperature.

In the lower face of the solid the bed temperature is applied, which produces a heat flow upwards (+Y axis). The funded polymer at 240°C (464°F) is applied in the upper face, producing a heat flow downwards. Both flows are produced by conduction. At the same time, thermal dissipation of heat is produced by convection between the solid's walls and the surrounding environment.

When the bed is at 70°C (158°F) the isothermal volume of the solid in the base starts at 58,9°C (138°F), due to the low thermal conductivity of ABS and a less responsive finite element mesh, as it is represented in Figure 6.

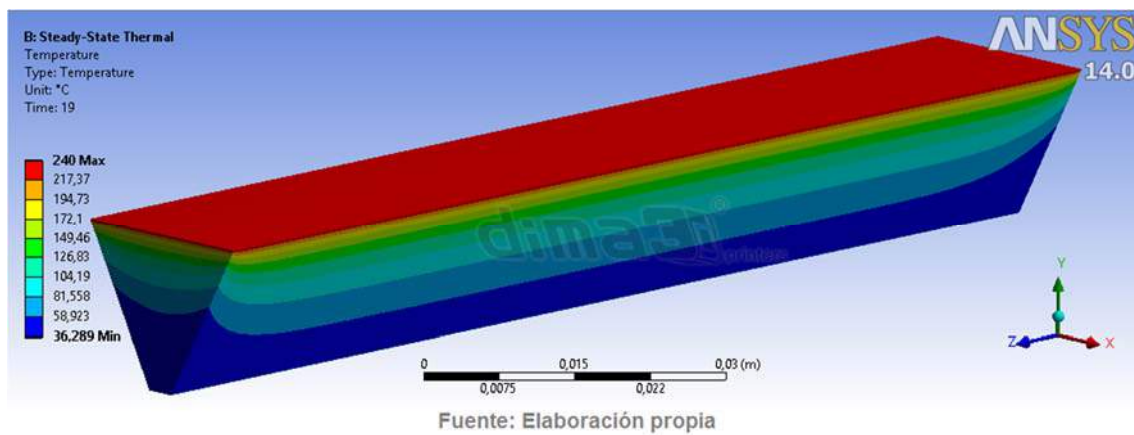

Figure 6. Thermal gradient with bed at 70°C (158°F)

However, an isothermal volume appears in the lower face of the piece by establishing the bed temperature at 80 °C (176°F), as it is shown in Figure 7 in light blue. It can be observed that the temperature gradient is not linear.

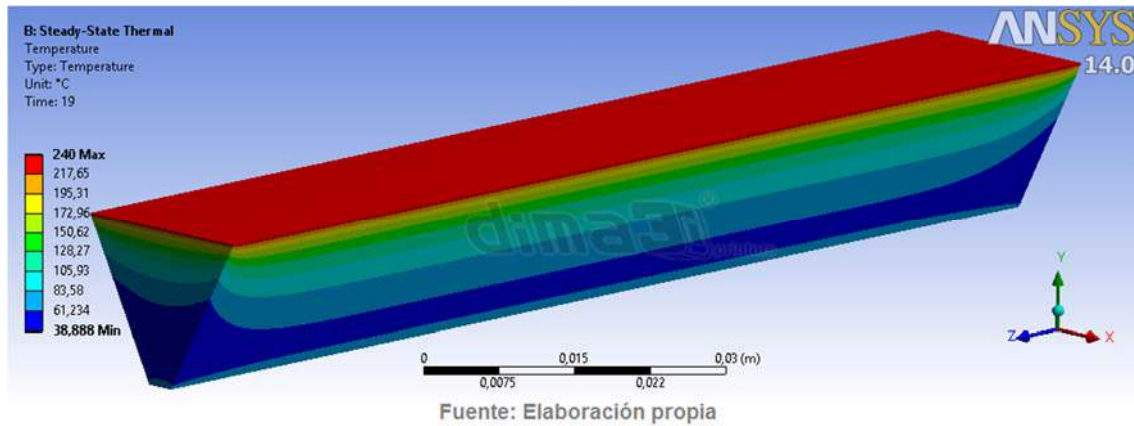

Figure 7. Thermal gradient with bed at 80°C (176°F)

In a similar way, by raising the temperature up to 90°C (194°F) as it is shown in Figure 8, the same isothermal volume grows respect to the previous case.

At the same time another positive consequence appears: with a higher temperature in the lower face, the value of the derivative of the multidimensional temperature gradient becomes lower, therefore showing that the temperature homogeneity increases inside the solid.

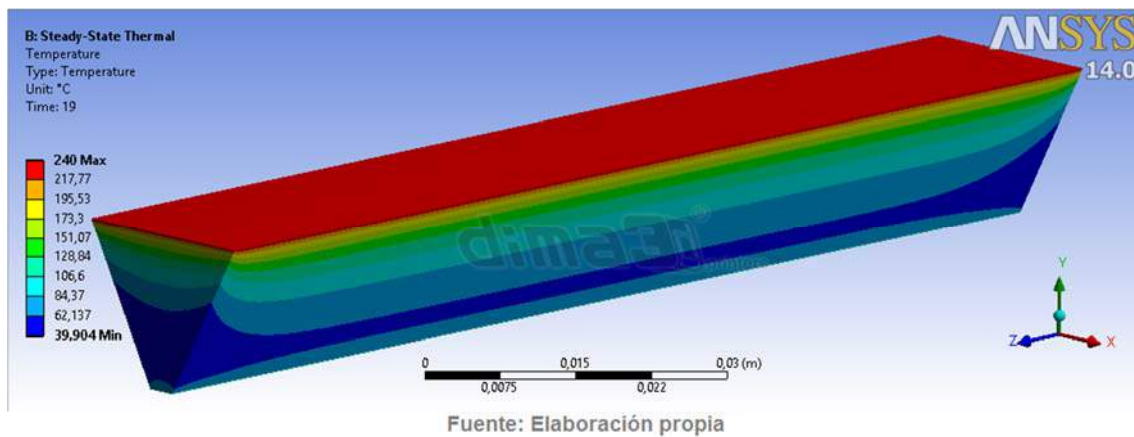

Figure 8. Thermal gradient with bed at 90°C (194°F)

Eventually, when the bed temperature is 110°C (230°F), following the previous argumentation, the homogeneity of temperature values increases more as two isothermal volumes join. Figure 9 shows this effect, where two isothermal volumes at lower temperature in the ends of the solid can be distinguished. Their multidimensional temperature gradient derivative will be maximum (although the tension between the solid and the substratum is also maximum). Next to the already described boundary conditions, this explains the appearance of internal tensions that create deformations in the ends, mainly caused by the deposition of funded material in the upper face.

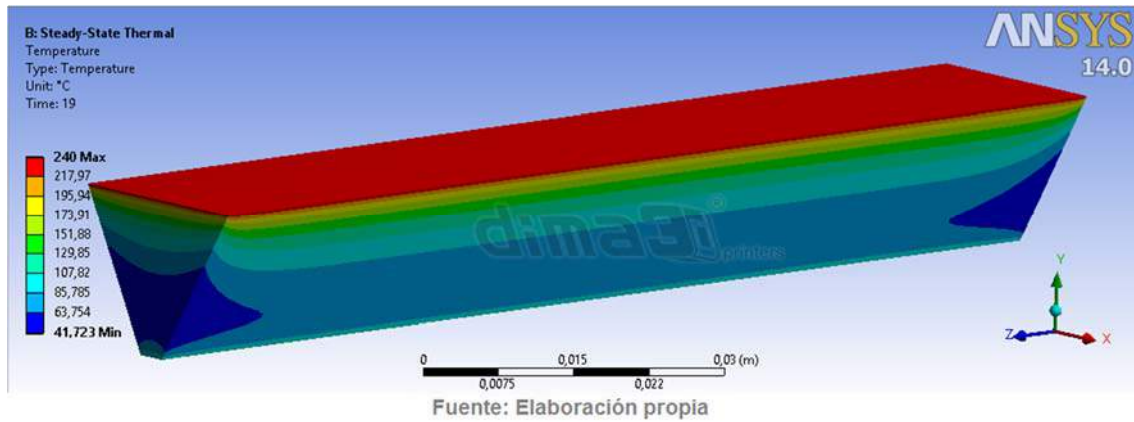

Figure 9. Thermal gradient with bed at 110°C (230°F)

During the printing, as it can be observed in Figures 6 to 9, the zone with lower temperature (50°C, 122°F) is reduced as the bed temperature is increased, making it more homogeneous along the solid. Therefore, we can conclude that the solid's thermal homogeneity increases with the bed temperature. Increasing the temperature homogeneity, the internal tensions created by large gradients in small differentials of the solid are reduced.

The final conclusion is that raising the bed temperature:

- the adherence properties of Dimafix® are activated,
- the solid's internal tensions are reduced, jointly with the bed interface provided by Dimafix®.



Analysis of deformations printing with ABS: warping

In this section we will study the deformation (“warping”) produced printing with ABS:

- first, without using Dimafix®;
- then, how the use of Dimafix® is capable of preventing warping completely.

The results will be analysed in terms of the highest deformation value measured. We will be able to conclude how the deformation value in the corners of the solid is significantly reduced when using Dimafix® instead of other common lacs.

This way, Figure 10 shows that a regular lac provides a deformation value of 2,089mm in the Y axis. In the Figures 11 to 14 it can be observed how this deformation value is significantly reduced as the bed temperature increases and Dimafix® is used. This is consistent with the adherence values represented in Figure 1 and their improvement with the bed temperature.

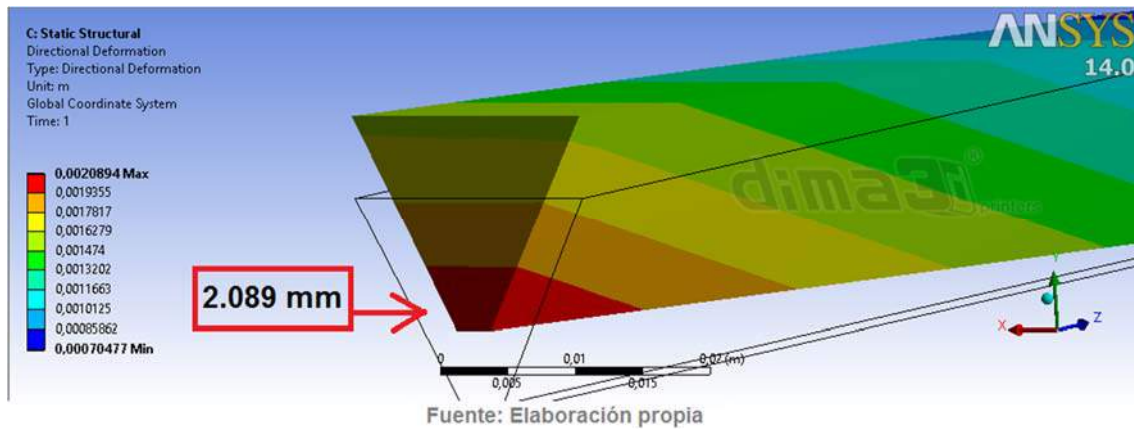

Figure 10. Deformation caused by internal tensions printing with regular lacs at 75°C (167°F)

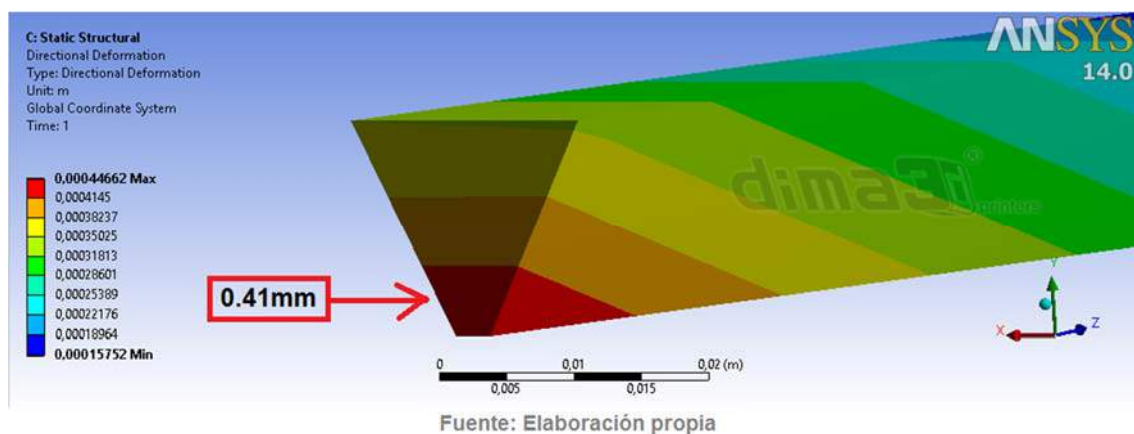

Figure 11. Deformation caused by internal tensions printing with Dimafix® at 75°C (167°F)

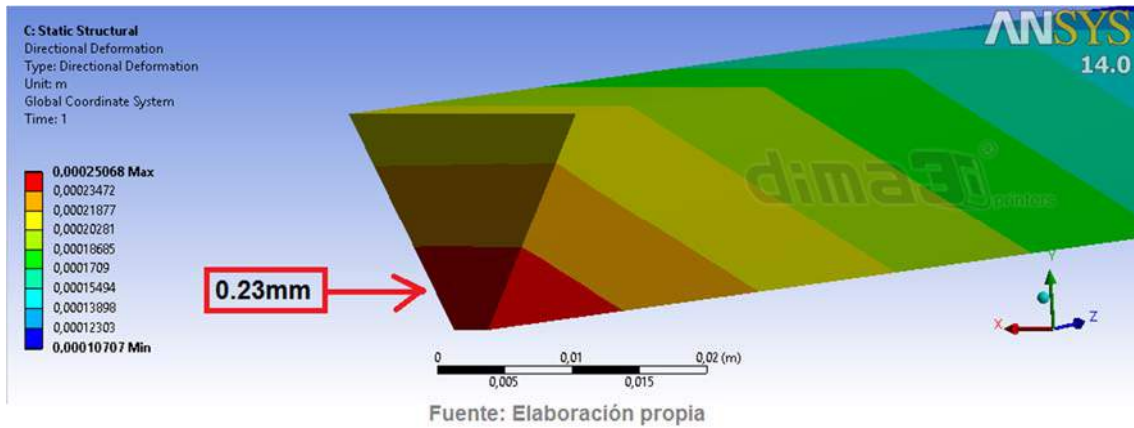

Figure 12. Deformation caused by internal tensions printing with Dimafix® at 80°C (176°F)



Figure 13. Deformation caused by internal tensions printing with Dimafix® at 90°C (194°F)

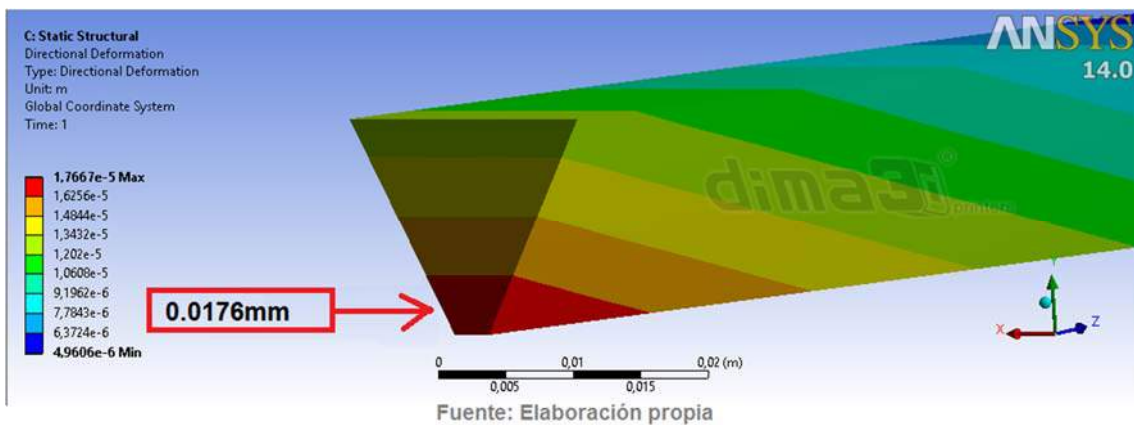

Figure 14. Deformation caused by internal tensions printing with Dimafix® at 110°C (230°F)

The deformations shown in the previous finite element analysis follow the Y axis in the relative coordinated system used. The colour scale values indicate deformation in meters in the lower end of the solid under study.



In the final step, this deformation in the end of the solid, where the tensions are maximum, will be studied. Figure 15 shows the local axis system used for this study.

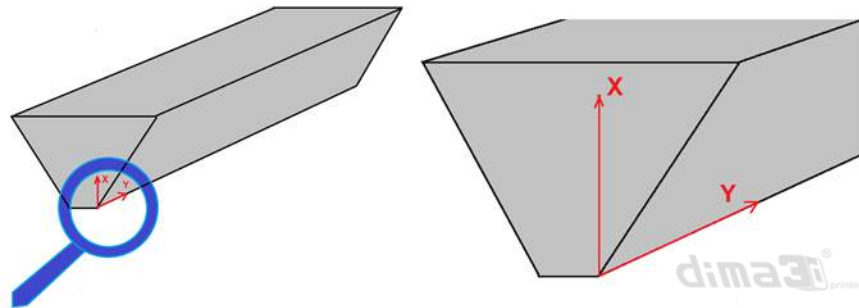

Figure 15. Axis system for the end deformation study

Figure 16 represents the results obtained from our study, comparing Dimafix® versus regular lacs, for bed temperatures from 75°C up to 110°C (167°–230°F). The results confirm that the deformations in the end of the solid are much smaller using Dimafix®.

This way, for 75°C (167°F), the deformation with the regular lac is already five times larger than the deformation with Dimafix® at the same temperature. As the bed temperature is increased, the adherence of Dimafix® becomes even stronger and the deformations become one hundred times smaller.

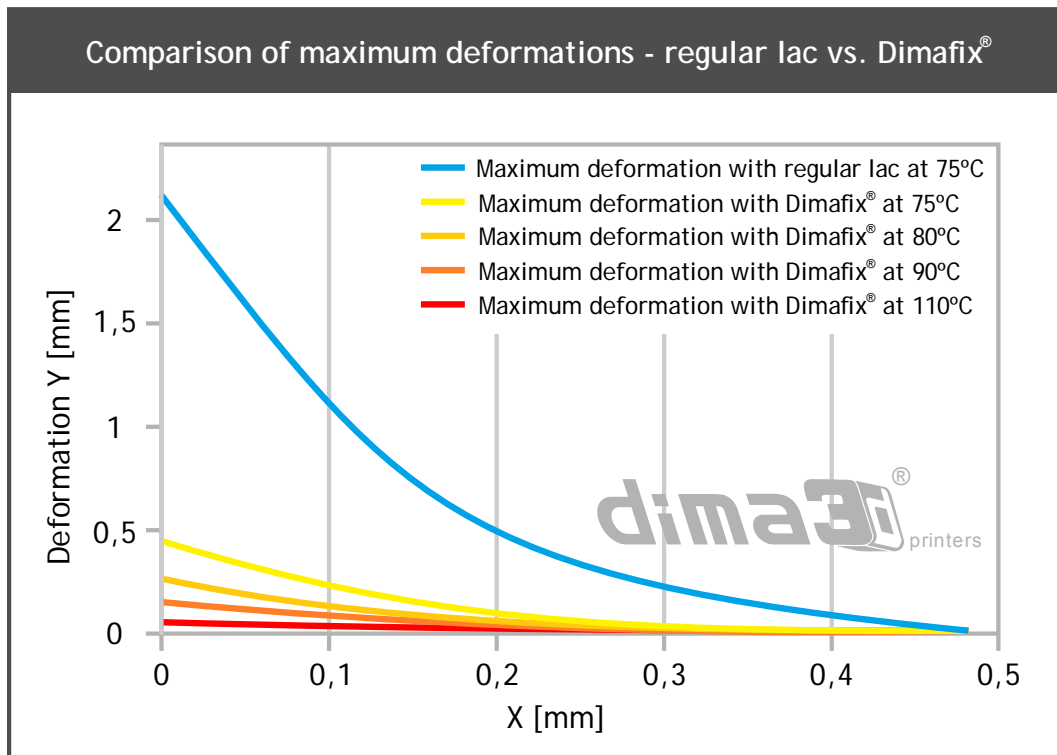

Figure 16. Deformations at different temperatures – Dimafix® vs regular lacs